

VENETIAN STOOL CLEAR MIRROR FINISH ASSEMBLY INSTRUCTIONS

Thank you for purchasing the VENETIAN STOOL CLEAR MIRROR FINISH.
Please read the instructions carefully to ensure safe operation of the product.

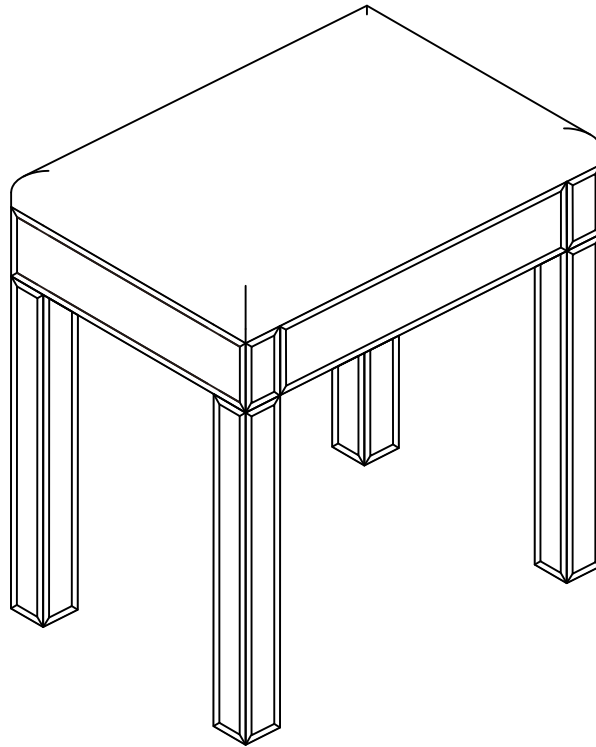

W420 x D300 x H460mm
COLOUR: CLEAR

PLEASE READ this sheet prior to assembly to familiarise yourself with the various stages of construction.

Carefully open the pack supplied and check the contents against the parts and fittings check list. Do not destroy any of the packaging until you are certain that you have all the necessary parts for the assembly.

CAUTION: There are small components used in the construction of this unit. These loose items should be kept away from young children whilst assembling your unit to avoid the danger of choking hazards.

Tools Required:

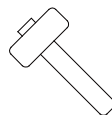

VENETIAN STOOL CLEAR MIRROR FINISH

ASSEMBLY INSTRUCTIONS

REFERENCE.

INFORMATION

Due to the size of this product we recommend that it is assembled in the room intended for use.
When you are ready to start, make sure that you have the right tools, plenty of space and a clean, dry area for assembly.
Unwrap all packaging materials and place the components on top of the carton box or on a clean floor to prevent it from scratching.
Check the pack and make sure you have all the parts listed.
Ensure that this product is fully assembled as illustrated before use.
Check all screws or bolts are tightened and inspect regularly
Tools are not included.
This product should only be used on firm, level ground.
Keep small parts out of reach of children.
Make sure the legs remain in contact with the ground.





WARNINGS

DO NOT use power tools to construct this product.
DO NOT tighten screws until fully assembled.
DO NOT over tighten screws or bolts.
DO NOT use this product if parts are missing, damaged or worn.
N.B. If in doubt please consult a qualified tradesperson. **Warning:** Always ensure the area to be drilled is free from hidden electrical wires, water and gas pipes.

CARE INFORMATION

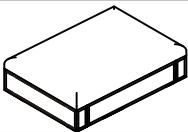
Never use scourers, abrasives or chemical cleaners.
To clean wipe with a sponge and warm soapy water. Do not use solvent based cleaners or detergents as they can bleach or damage the product.

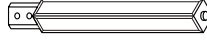
VENETIAN STOOL CLEAR MIRROR FINISH ASSEMBLY INSTRUCTIONS

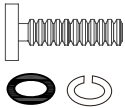
| Ref | Thumbnail | Qty |
|-----|---|-----|
| A |  | 1 |
| 1 |  | 1 |
| 2 |  | 1 |
| 3 |  | 1 |
| 4 |  | 1 |
| B |  | 1 |
| C |  | 8 |

CAUTION: There are many small components used in the construction of this product. Please keep these components away from young children whilst assembling this product.

If you keep the fittings in a bowl during assembly you will be less likely to lose them!

VENETIAN STOOL CLEAR MIRROR FINISH ASSEMBLY INSTRUCTIONS

